

Product datasheet

Specifications



variable speed drive ATV12 -
0.75kW - 1hp - 100..120V - 1ph -
with heat sink

ATV12H075F1

Main

Range of product	Altivar 12
Product or component type	Variable speed drive
Product specific application	Simple machine
Mounting mode	Cabinet mount
Communication port protocol	Modbus
Supply frequency	50/60 Hz +/- 5 %
[Us] rated supply voltage	100...120 V - 15...10 %
Nominal output current	4.2 A
Motor power hp	1 hp
Motor power kW	0.75 kW 1 hp
EMC filter	Without EMC filter
IP degree of protection	IP20

Complementary

Discrete input number	4
Discrete output number	2
Analogue input number	1
Analogue output number	1
Relay output number	1
Physical interface	2-wire RS 485
Connector type	1 RJ45
Continuous output current	4.2 A at 4 kHz
Method of access	Server Modbus serial
Speed drive output frequency	0.5...400 Hz
Speed range	1...20
Sampling duration	20 ms, tolerance +/- 1 ms for logic input 10 ms for analogue input
Linearity error	+/- 0.3 % of maximum value for analogue input
Frequency resolution	Analog input: converter A/D, 10 bits

Display unit: 0.1 Hz

Time constant	20 ms +/- 1 ms for reference change
Transmission rate	9.6 kbit/s 19.2 kbit/s 38.4 kbit/s
Transmission frame	RTU
Number of addresses	1...247
Data format	8 bits, configurable odd, even or no parity
Communication service	Read holding registers (03) 29 words Write single register (06) 29 words Write multiple registers (16) 27 words Read/write multiple registers (23) 4/4 words Read device identification (43)
Type of polarization	No impedance
4 quadrant operation possible	False
Asynchronous motor control profile	Voltage/frequency ratio (V/f) Quadratic voltage/frequency ratio Sensorless flux vector control
Maximum output frequency	4 kHz
Transient overtorque	150...170 % of nominal motor torque depending on drive rating and type of motor
Acceleration and deceleration ramps	Linear from 0 to 999.9 s S U
Motor slip compensation	Preset in factory Adjustable
Switching frequency	2...16 kHz adjustable 4...16 kHz with derating factor
Nominal switching frequency	4 kHz
Braking to standstill	By DC injection
Brake chopper integrated	False
Line current	18.9 A at 100 V (heavy duty) 15.7 A at 120 V (heavy duty)
Maximum input current	15.7 A
Maximum output voltage	240 V
Apparent power	1.9 kVA at 240 V (heavy duty)
Maximum transient current	6.3 A during 60 s (heavy duty) 6.9 A during 2 s (heavy duty)
Network frequency	50...60 Hz
Relative symmetric network frequency tolerance	5 %
Prospective line I_{sc}	1 kA
Base load current at high overload	4.2 A
Power dissipation in W	Forced cooling: 48.0 W
With safety function Safely Limited Speed (SLS)	False
With safety function Safe brake management (SBC/SBT)	False
With safety function Safe Operating Stop (SOS)	False
With safety function Safe Position (SP)	False
With safety function Safe programmable logic	False

With safety function Safe Speed Monitor (SSM)	False
With safety function Safe Stop 1 (SS1)	False
With sft fct Safe Stop 2 (SS2)	False
With safety function Safe torque off (STO)	False
With safety function Safely Limited Position (SLP)	False
With safety function Safe Direction (SDI)	False
Protection type	Line supply overvoltage Line supply undervoltage Overcurrent between output phases and earth Overheating protection Short-circuit between motor phases Against input phase loss in three-phase Thermal motor protection via the drive by continuous calculation of I ² t
Tightening torque	1.2 N.m
Insulation	Electrical between power and control
Quantity per set	Set of 1
Width	105 mm
Height	142 mm
Depth	156.2 mm
Net weight	1.3 kg

Environment

Operating altitude	> 1000...2000 m with current derating 1 % per 100 m <= 1000 m without derating
Operating position	Vertical +/- 10 degree
Product certifications	NOM CSA C-Tick UL GOST RCM KC
Marking	CE
Standards	UL 508C UL 618000-5-1 EN/IEC 61800-5-1 EN/IEC 61800-3
Assembly style	With heat sink
Electromagnetic compatibility	Electrical fast transient/burst immunity test level 4 conforming to EN/IEC 61000-4-4 Electrostatic discharge immunity test level 3 conforming to EN/IEC 61000-4-2 Immunity to conducted disturbances level 3 conforming to EN/IEC 61000-4-6 Radiated radio-frequency electromagnetic field immunity test level 3 conforming to EN/IEC 61000-4-3 Surge immunity test level 3 conforming to EN/IEC 61000-4-5 Voltage dips and interruptions immunity test conforming to EN/IEC 61000-4-11
Environmental class (during operation)	Class 3C3 according to IEC 60721-3-3 Class 3S2 according to IEC 60721-3-3
Maximum acceleration under shock impact (during operation)	150 m/s ² at 11 ms
Maximum acceleration under vibrational stress (during operation)	10 m/s ² at 13...200 Hz
Maximum deflection under vibratory load (during operation)	1.5 mm at 2...13 Hz
Volume of cooling air	16 m ³ /h

Overvoltage category	Class III
Regulation loop	Adjustable PID regulator
Electromagnetic emission	Radiated emissions environment 1 category C2 conforming to EN/IEC 61800-3 2...16 kHz shielded motor cable Conducted emissions with additional EMC filter environment 1 category C1 conforming to EN/IEC 61800-3 4...12 kHz shielded motor cable <5 m Conducted emissions with additional EMC filter environment 1 category C2 conforming to EN/IEC 61800-3 4...12 kHz shielded motor cable <20 m Conducted emissions with additional EMC filter environment 2 category C3 conforming to EN/IEC 61800-3 4...12 kHz shielded motor cable <20 m
Vibration resistance	1 gn (f = 13...200 Hz) conforming to EN/IEC 60068-2-6 1.5 mm peak to peak (f = 3...13 Hz) - drive unmounted on symmetrical DIN rail - conforming to EN/IEC 60068-2-6
Shock resistance	15 gn conforming to EN/IEC 60068-2-27 for 11 ms
Relative humidity	5...95 % without condensation conforming to IEC 60068-2-3 5...95 % without dripping water conforming to IEC 60068-2-3
Noise level	45 dB
Pollution degree	2
Ambient air transport temperature	-25...70 °C
Ambient air temperature for operation	-10...50 °C without derating 50...60 °C with current derating 2.2 % per °C
Ambient air temperature for storage	-25...70 °C

Packing Units

Unit Type of Package 1	PCE
Package 1 Length	19.0 cm
Number of Units in Package 1	1
Package 2 Width	60 cm
Package 2 Height	75 cm
Package 2 Weight	59.6 kg
Package 3 Height	80 cm
Package 1 Width	19.5 cm
Package 1 Height	17.0 cm
Package 1 Weight	1.587 kg
Number of Units in Package 2	30
Unit Type of Package 2	P06
Package 2 Length	80 cm

Offer Sustainability

Sustainable offer status	Green Premium product
REACH Regulation	REACH Declaration
EU RoHS Directive	Pro-active compliance (Product out of EU RoHS legal scope) EU RoHS Declaration
Mercury free	Yes
RoHS exemption information	Yes
China RoHS Regulation	China RoHS declaration
Environmental Disclosure	Product Environmental Profile
Circularity Profile	End of Life Information

WEEE

The product must be disposed on European Union markets following specific waste collection and never end up in rubbish bins

Contractual warranty

Warranty

18 months

Dimensions

Drive without EMC Conformity Kit

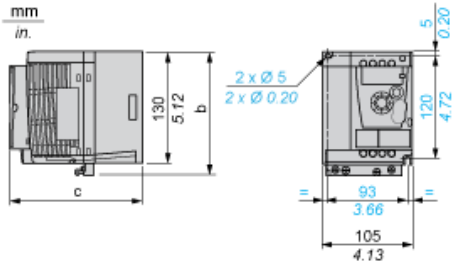

Dimensions in mm

b	c
142	156.2

Dimensions in in.

b	c
5.59	6.15

Drive with EMC Conformity Kit

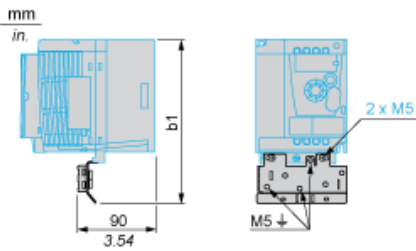

Dimensions in mm

b1
188.2

Dimensions in in.

b1
7.41

Mounting Recommendations

Clearance for Vertical Mounting

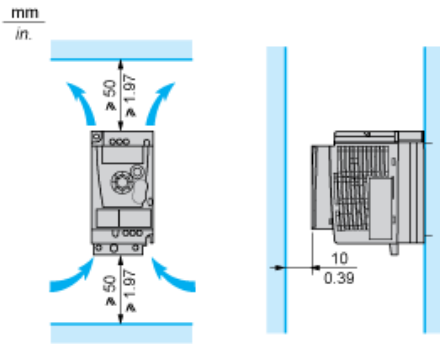

Mounting Type A

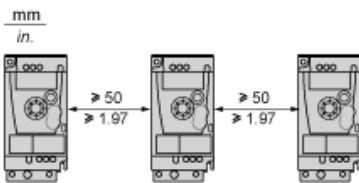

Mounting Type B

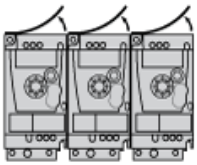

Remove the protective cover from the top of the drive.

Mounting Type C

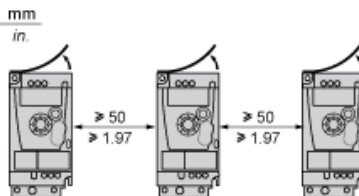

Remove the protective cover from the top of the drive.

Single-Phase Power Supply Wiring Diagram

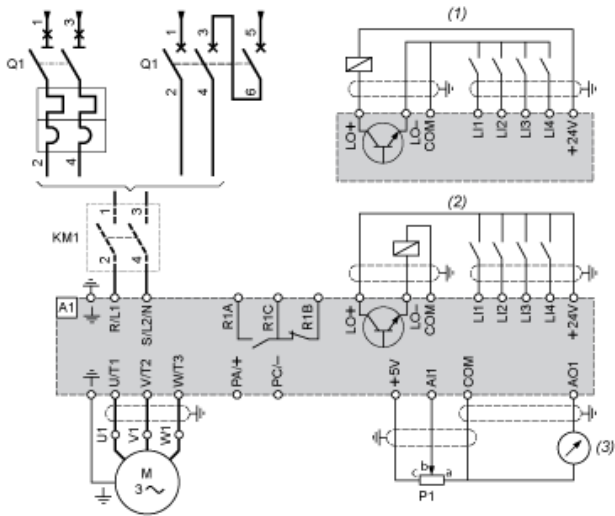

- A1** Drive
- KM1** Contactor (only if a control circuit is needed)
- P1** 2.2 kΩ reference potentiometer. This can be replaced by a 10 kΩ potentiometer (maximum).
- Q1** Circuit breaker
- (1)** Negative logic (Sink)
- (2)** Positive logic (Source) (factory set configuration)
- (3)** 0...10 V or 0...20 mA

Recommended Schemes

2-Wire Control for Logic I/O with Internal Power Supply

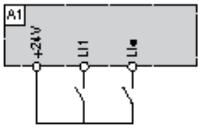

LI1 : Forward
LIe : Reverse
A1 : Drive

3-Wire Control for Logic I/O with Internal Power Supply

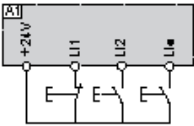

LI1 : Stop
LI2 : Forward
LIe : Reverse
A1 : Drive

Analog Input Configured for Voltage with Internal Power Supply

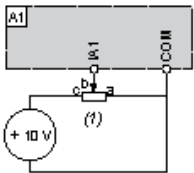

(1) 2.2 kΩ...10 kΩ reference potentiometer
A1 : Drive

Analog Input Configured for Current with Internal Power Supply

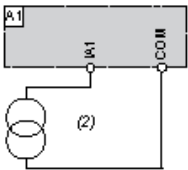

(2) 0-20 mA 4-20 mA supply
A1 : Drive

Connected as Positive Logic (Source) with External 24 vdc Supply

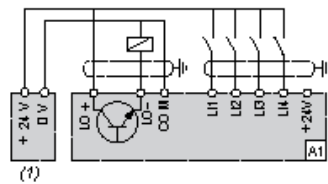

(1) 24 vdc supply
A1 : Drive

Connected as Negative Logic (Sink) with External 24 vdc supply

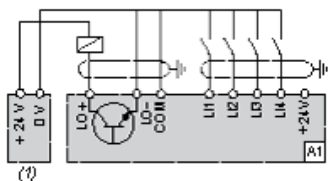

(1) 24 vdc supply
A1 : Drive

Torque Curves

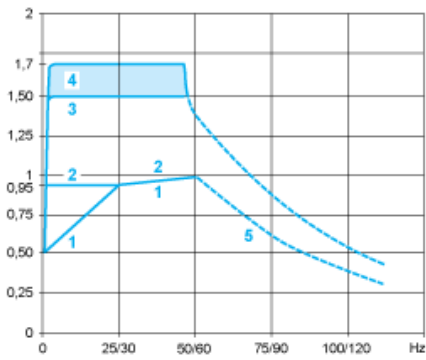

- 1 : Self-cooled motor: continuous useful torque (1)
- 2 : Force-cooled motor: continuous useful torque
- 3 : Transient overtorque for 60 s
- 4 : Transient overtorque for 2 s
- 5 : Torque in overspeed at constant power (2)
- (1) For power ratings ≤ 250 W, derating is 20% instead of 50% at very low frequencies.
- (2) The nominal motor frequency and the maximum output frequency can be adjusted from 0.5 to 400 Hz. The mechanical overspeed capability of the motor is 150%.