

Product data sheet

Specifications



Logic controller, Modicon M221, 40 IO transistor PNP

TM221C40T

Main

| | |
|---------------------------|--|
| Range of product | Modicon M221 |
| Product or component type | Logic controller |
| [Us] rated supply voltage | 24 V DC |
| Discrete input number | 24, discrete input 4 fast input conforming to IEC 61131-2 Type 1 |
| Analogue input number | 2 at 0...10 V |
| Discrete output type | Transistor |
| Discrete output number | 16 transistor 2 fast output |
| Discrete output voltage | 24 V DC |
| Discrete output current | 0.5 A |

Complementary

| | |
|--|--|
| Discrete I/O number | 40 |
| Maximum number of I/O expansion module | 7 for relay output |
| Supply voltage limits | 20.4...28.8 V |
| Inrush current | 35 A |
| Maximum power consumption in W | 4.1 W at 24 V (without I/O expansion module) 16 W at 24 V (with max number of I/O expansion module) |
| Power supply output current | 0.52 A 5 V for expansion bus 0.3 A 24 V for expansion bus |
| Discrete input logic | Sink or source (positive/negative) |
| Discrete input voltage | 24 V |
| Discrete input voltage type | DC |
| Analogue input resolution | 10 bits |
| LSB value | 10 mV |
| Conversion time | 1 ms per channel + 1 controller cycle time for analogue input analog input |
| Permitted overload on inputs | +/- 30 V DC for 5 min (maximum) for analog input +/- 13 V DC (permanent) for analog input |
| Voltage state 1 guaranteed | ≥ 15 V for input |
| Voltage state 0 guaranteed | ≤ 5 V for input |
| Discrete input current | 7 mA for discrete input 5 mA for fast input |

| | |
|--|---|
| Input impedance | 3.4 kOhm for discrete input 100 kOhm for analog input 4.9 kOhm for fast input |
| Response time | 35 µs turn-off, I2...I5 terminal(s) for input 5 µs turn-on, I0, I1, I6, I7 terminal(s) for fast input 35 µs turn-on, other terminals terminal(s) for input 5 µs turn-off, I0, I1, I6, I7 terminal(s) for fast input 100 µs turn-off, other terminals terminal(s) for input 5 µs turn-on, turn-off, Q0...Q1 terminal(s) for output 50 µs turn-on, turn-off, Q2...Q3 terminal(s) for output 300 µs turn-on, turn-off, other terminals terminal(s) for output |
| Configurable filtering time | 0 ms for input 3 ms for input 12 ms for input |
| Discrete output logic | Positive logic (source) |
| Maximum current per output common | 4 A |
| Output frequency | 100 kHz for fast output (PWM/PLS mode) at Q0...Q1 5 kHz for output at Q2...Q3 0.1 kHz for output at Q4...Q15 |
| Absolute accuracy error | +/- 1 % of full scale for analog input |
| Maximum leakage current | 0.1 mA for transistor output |
| Maximum voltage drop | <1 V |
| Mechanical durability | 20000000 cycles for transistor output |
| Maximum tungsten load | <12 W for output and fast output |
| Protection type | Overload and short-circuit protection at 1 A |
| Reset time | 1 s automatic reset |
| Memory capacity | 256 kB for user application and data RAM with 10000 instructions 256 kB for internal variables RAM |
| Data backed up | 256 kB built-in flash memory for backup of application and data |
| Data storage equipment | 2 GB SD card (optional) |
| Battery type | BR2032 lithium non-rechargeable, battery life: 4 year(s) |
| Backup time | 1 year at 25 °C (by interruption of power supply) |
| Execution time for 1 KInstruction | 0.3 ms for event and periodic task |
| Execution time per instruction | 0.2 µs Boolean |
| Exct time for event task | 60 µs response time |
| Maximum size of object areas | 255 %TM timers 512 %M memory bits 255 %C counters 512 %KW constant words 8000 %MW memory words |
| Realtime clock | With |
| Clock drift | <= 30 s/month at 25 °C |
| Regulation loop | Adjustable PID regulator up to 14 simultaneous loops |
| Positioning functions | Position PTO 2 axe(s)pulse/direction mode (100 kHz) Position PTO 1 axe(s)CW/CCW mode (100 kHz) |
| Function available | Frequency generator PWM PLS |
| Counting input number | 4 fast input (HSC mode) at 100 kHz 32 bits |
| Counter function | Pulse/direction Single phase A/B |
| Integrated connection type | USB port with mini B USB 2.0 connector Non isolated serial link serial 1 with RJ45 connector and RS485 interface Non isolated serial link serial 2 with RJ45 connector and RS232/RS485 interface |

| | |
|---|--|
| Supply | (serial)serial link supply: 5 V, <200 mA |
| Transmission rate | 1.2...115.2 kbit/s (115.2 kbit/s by default) for bus length of 15 m for RS485 1.2...115.2 kbit/s (115.2 kbit/s by default) for bus length of 3 m for RS232 480 Mbit/s for USB |
| Communication port protocol | USB port: USB - SoMachine-Network Non isolated serial link: Modbus master/slave - RTU/ASCII or SoMachine-Network |
| Local signalling | 1 LED (green) for PWR 1 LED (green) for RUN 1 LED (red) for module error (ERR) 1 LED (green) for SD card access (SD) 1 LED (red) for BAT 1 LED (green) for SL1 1 LED (green) for SL2 1 LED per channel (green) for I/O state |
| Electrical connection | removable screw terminal block for inputs removable screw terminal block for outputs terminal block, 3 terminal(s) for connecting the 24 V DC power supply connector, 4 terminal(s) for analogue inputs Mini B USB 2.0 connector for a programming terminal |
| Maximum cable distance between devices | Shielded cable: <10 m for fast input Unshielded cable: <30 m for output Unshielded cable: <30 m for digital input Unshielded cable: <1 m for analog input Shielded cable: <3 m for fast output |
| Insulation | Between input and internal logic at 500 V AC Between fast input and internal logic at 500 V AC Non-insulated between inputs Between output and internal logic at 500 V AC Non-insulated between analogue input and internal logic Non-insulated between analogue inputs |
| Marking | CE |
| Mounting support | Top hat type TH35-15 rail conforming to IEC 60715 Top hat type TH35-7.5 rail conforming to IEC 60715 plate or panel with fixing kit |
| Height | 90 mm |
| Depth | 70 mm |
| Width | 160 mm |
| Net weight | 0.456 kg |

Environment

| | |
|--|---|
| Standards | EN/IEC 61131-2 EN/IEC 60664-1 EN/IEC 61010-2-201 |
| Product certifications | CSA IACS E10 DNV-GL ABS EAC cULus RCM LR |
| Environmental characteristic | Ordinary and hazardous location |
| Resistance to electrostatic discharge | 8 kV in air conforming to EN/IEC 61000-4-2 4 kV on contact conforming to EN/IEC 61000-4-2 |
| Resistance to electromagnetic fields | 10 V/m 80 MHz...1 GHz conforming to EN/IEC 61000-4-3 3 V/m 1.4 GHz...2 GHz conforming to EN/IEC 61000-4-3 1 V/m 2...2.7 GHz conforming to EN/IEC 61000-4-3 |
| Resistance to magnetic fields | 30 A/m 50/60 Hz conforming to EN/IEC 61000-4-8 |
| Resistance to fast transients | 2 kV (power lines) conforming to EN/IEC 61000-4-4 2 kV (relay output) conforming to EN/IEC 61000-4-4 1 kV (I/O) conforming to EN/IEC 61000-4-4 1 kV (Ethernet line) conforming to EN/IEC 61000-4-4 1 kV (serial link) conforming to EN/IEC 61000-4-4 |
| Surge withstand | 2 kV power lines (AC) common mode conforming to EN/IEC 61000-4-5 2 kV relay output common mode conforming to EN/IEC 61000-4-5 1 kV I/O common mode conforming to EN/IEC 61000-4-5 1 kV shielded cable common mode conforming to EN/IEC 61000-4-5 0.5 kV power lines (DC) differential mode conforming to EN/IEC 61000-4-5 1 kV power lines (AC) differential mode conforming to EN/IEC 61000-4-5 |

1 kV relay output differential mode conforming to EN/IEC 61000-4-5
0.5 kV power lines (DC) common mode conforming to EN/IEC 61000-4-5

| | |
|--|--|
| Resistance to conducted disturbances | 10 V 0.15...80 MHz conforming to EN/IEC 61000-4-6 3 V 0.1...80 MHz conforming to Marine specification (LR, ABS, DNV, GL) 10 V spot frequency (2, 3, 4, 6.2, 8.2, 12.6, 16.5, 18.8, 22, 25 MHz) conforming to Marine specification (LR, ABS, DNV, GL) |
| Electromagnetic emission | Conducted emissions - test level: 79 dB μ V/m QP/66 dB μ V/m AV (power lines (AC)) at 0.15...0.5 MHz conforming to EN/IEC 55011 Conducted emissions - test level: 73 dB μ V/m QP/60 dB μ V/m AV (power lines (AC)) at 0.5...300 MHz conforming to EN/IEC 55011 Conducted emissions - test level: 120...69 dB μ V/m QP (power lines) at 10...150 kHz conforming to EN/IEC 55011 Conducted emissions - test level: 63 dB μ V/m QP (power lines) at 1.5...30 MHz conforming to EN/IEC 55011 Radiated emissions - test level: 40 dB μ V/m QP class A (10 m) at 30...230 MHz conforming to EN/IEC 55011 Conducted emissions - test level: 79...63 dB μ V/m QP (power lines) at 150...1500 kHz conforming to EN/IEC 55011 Radiated emissions - test level: 47 dB μ V/m QP class A (10 m) at 200...1000 MHz conforming to EN/IEC 55011 |
| Immunity to microbreaks | 10 ms |
| Ambient air temperature for operation | -10...55 °C (horizontal installation) -10...35 °C (vertical installation) |
| Ambient air temperature for storage | -25...70 °C |
| Relative humidity | 10...95 %, without condensation (in operation) 10...95 %, without condensation (in storage) |
| IP degree of protection | IP20 with protective cover in place |
| Pollution degree | <= 2 |
| Operating altitude | 0...2000 m |
| Storage altitude | 0...3000 m |
| Vibration resistance | 3.5 mm at 5...8.4 Hz on symmetrical rail 3.5 mm at 5...8.4 Hz on panel mounting 1 gn at 8.4...150 Hz on symmetrical rail 1 gn at 8.4...150 Hz on panel mounting |
| Shock resistance | 147 m/s ² for 11 ms |

Packing Units

| | |
|-------------------------------------|-----------|
| Unit Type of Package 1 | PCE |
| Number of Units in Package 1 | 1 |
| Package 1 Height | 11.172 cm |
| Package 1 Width | 14.117 cm |
| Package 1 Length | 21.084 cm |
| Package 1 Weight | 750.0 g |
| Unit Type of Package 2 | CAR |
| Number of Units in Package 2 | 12 |
| Package 2 Height | 29.2 cm |
| Package 2 Width | 39.6 cm |
| Package 2 Length | 56.8 cm |
| Package 2 Weight | 10.101 kg |

Offer Sustainability

| | |
|---------------------------------|---|
| Sustainable offer status | Green Premium product |
| REACH Regulation | REACH Declaration |
| EU RoHS Directive | Pro-active compliance (Product out of EU RoHS legal scope) EU RoHS Declaration |

| | |
|-----------------------------------|---|
| Mercury free | Yes |
| RoHS exemption information | Yes |
| China RoHS Regulation | China RoHS declaration |
| Environmental Disclosure | Product Environmental Profile |
| Circularity Profile | End of Life Information |
| WEEE | The product must be disposed on European Union markets following specific waste collection and never end up in rubbish bins |
| PVC free | Yes |
| California proposition 65 | WARNING: This product can expose you to chemicals including: Lead and lead compounds, which is known to the State of California to cause cancer and birth defects or other reproductive harm. For more information go to www.P65Warnings.ca.gov |

Dimensions

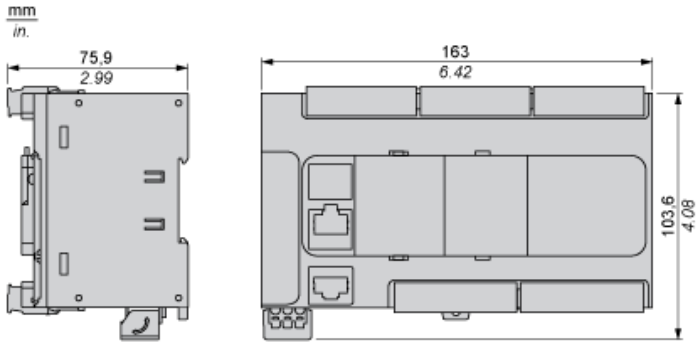

Mounting on a Rail

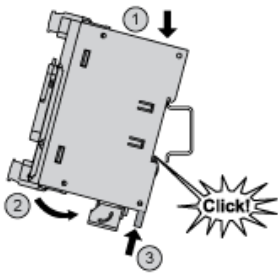

Direct Mounting on a Panel Surface

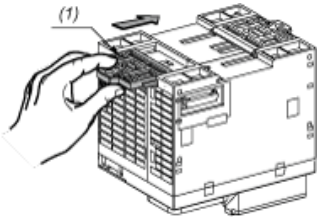

(1) Install a mounting strip

Mounting Hole Layout

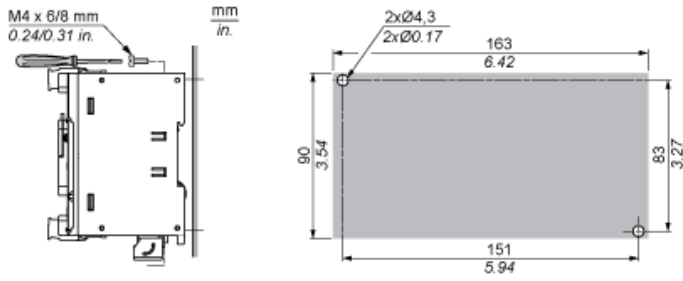

Mounting

Correct Mounting Position

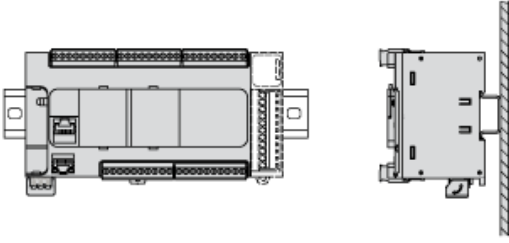

Acceptable Mounting Position

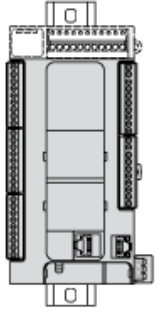

Incorrect Mounting Position

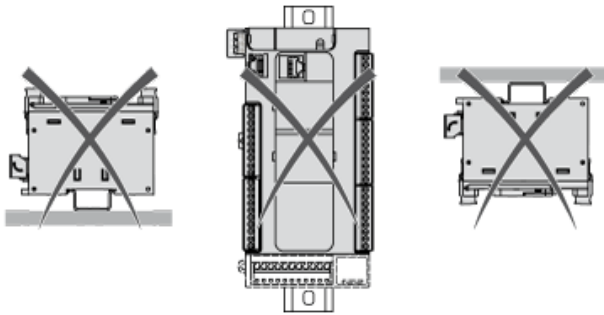

Clearance

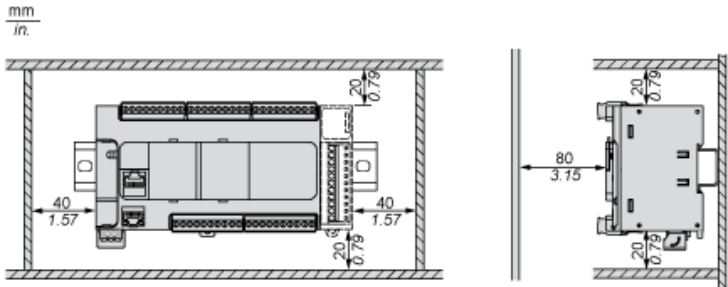

Digital Inputs

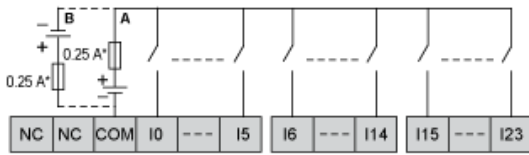

- (*) Type T fuse
- (A) Sink wiring (positive logic).
- (B) Source wiring (negative logic).

Connection of the Fast Inputs

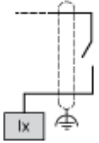

I0, I1, I6, I7

Transistor Outputs

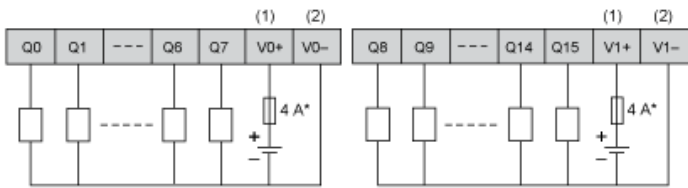

- (*) Type T fuse
- (1) The V0+ and V1+ terminals are **not** connected internally.
- (2) The V0- and V1- terminals are **not** connected internally.

Connection of the Fast Outputs

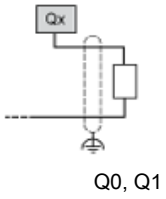

Analog Inputs

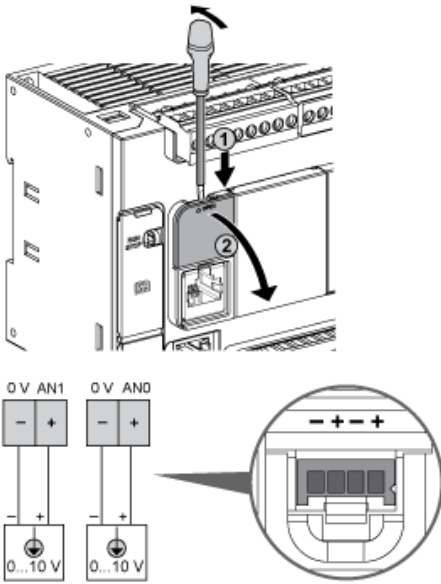

The (-) poles are connected internally.

| Pin | Wire Color |
|-----|------------|
| 0 V | Black |
| AN1 | Red |
| 0 V | Black |
| AN0 | Red |

USB Mini-B Connection

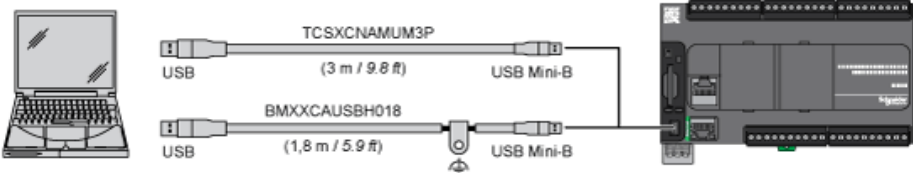

SL1 Connection

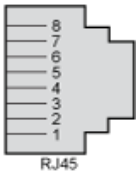

SL1

| N ° | RS 232 | RS 485 |
|-----|--------|--------|
| 1 | RxD | N.C. |
| 2 | TxD | N.C. |
| 3 | RTS | N.C. |
| 4 | N.C. | D1 |
| 5 | N.C. | D0 |
| 6 | CTS | N.C. |
| 7 | N.C.* | 5 Vdc |
| 8 | Common | Common |

N.C.: not connected

* : 5 Vdc delivered by the controller. Do not connect.

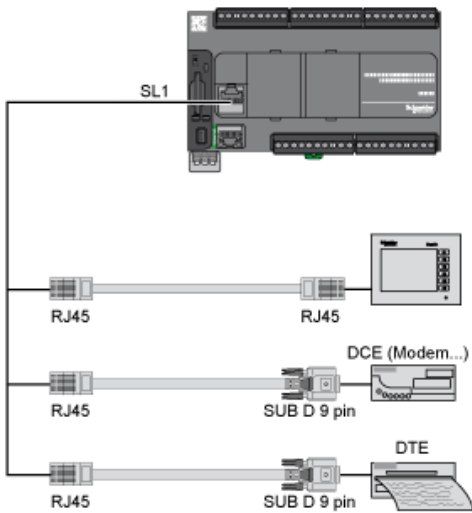

SL2 Connection

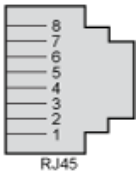

| N ° | RS 485 |
|-----|--------|
| 1 | N.C. |
| 2 | N.C. |
| 3 | N.C. |
| 4 | D1 |
| 5 | D0 |
| 6 | N.C. |
| 7 | N.C. |
| 8 | Common |

N.C.: not connected

Derating Curves

Embedded Digital Inputs (No Cartridge)

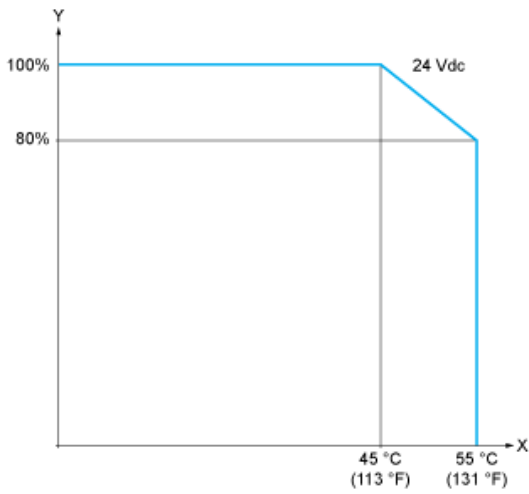

X : Ambient temperature
Y : Input simultaneous ON ratio

Embedded Digital Inputs (with Cartridge)

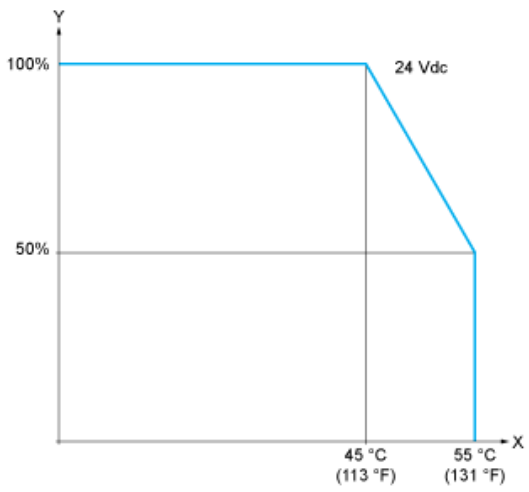

X : Ambient temperature
Y : Input simultaneous ON ratio

Derating Curves

Embedded Digital Outputs (No Cartridge)

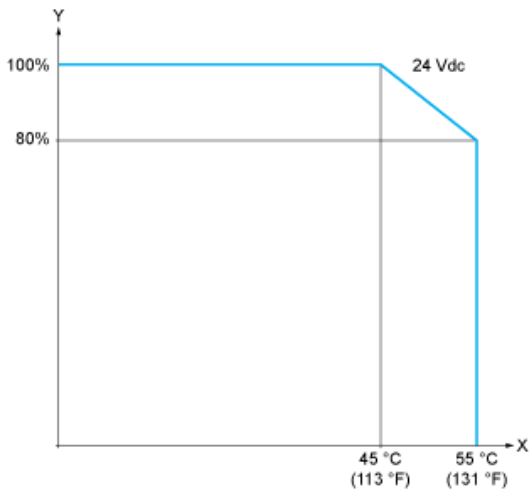

X : Ambient temperature
Y : Output simultaneous ON ratio

Embedded Digital Outputs (with Cartridge)

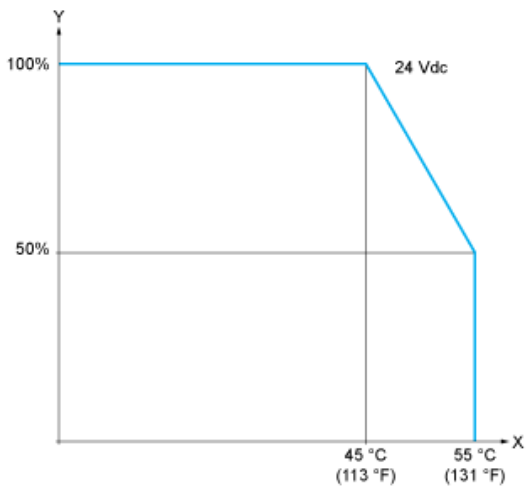

X : Ambient temperature
Y : Output simultaneous ON ratio

Recommended replacement(s)