



Main

Range of product	OsiSense XC
Series name	Basic
Product or component type	Limit switch
Product specific application	Light to medium duty
Device short name	XCJ
Body type	Fixed
Head type	Plunger head
Material	Plastic and metal
Fixing mode	By the body
Movement of operating head	Linear
Type of operator	Spring return roller plunger stainless steel
Switch actuation	On end
Type of approach	Traverse approach, 1 direction
Electrical connection	Screw-clamp terminals
Cable entry	1 flexible rubber cable gland, cable outer diameter: 8.5...10.5 mm
Number of poles	1
Contact operation	Snap action
Positive opening	Without
Maximum force for tripping	4 N

Complementary

Contacts insulation form	C
Minimum release force	0.98 N
Minimum actuation speed	0.01 mm/s
Maximum actuation speed	0.5 m/s
Maximum operating rate	120 cyc/mn
Contact code designation	A300, AC (U _e = 240 V), I _e = 10 A, I _{the} = 10 A conforming to IEC 60947-5-1 R300, DC (U _e = 220 V), I _e = 0.3 A conforming to IEC 60947-5-1
Maximum resistance across terminals	25 MOhm
[U _{imp}] rated impulse withstand voltage	4 kV conforming to EN/IEC 60664
Electrical durability	800000 cycles, AC, 10 A, 220 V
Mechanical durability	10000000 cycles
Width	22 mm
Height	79 mm
Depth	70 mm
Net weight	0.093 kg
Terminals description ISO n°1	(NO-NC-C)OF

Environment



Shock resistance	10 gn for 11 ms conforming to IEC 60068-2-27
Vibration resistance	+/- 3 mm (f= 10...55 Hz) conforming to IEC 60068-2-6
IP degree of protection	IP40 conforming to IEC 60529
Electrical shock protection class	Class II conforming to EN/IEC 60947-5-1
Ambient air temperature for operation	-25...70 °C

Ambient air temperature for storage	-40...70 °C
Marking	CE CCC
Standards	IEC 60947-5-1 GB 14048.5

Packing Units

Unit Type of Package 1	PCE
Number of Units in Package 1	1
Package 1 Height	2.000 cm
Package 1 Width	7.000 cm
Package 1 Length	7.500 cm
Package 1 Weight	94.000 g
Unit Type of Package 2	S03
Number of Units in Package 2	150
Package 2 Height	30.000 cm
Package 2 Width	30.000 cm
Package 2 Length	40.000 cm
Package 2 Weight	15.329 kg
Unit Type of Package 3	P06
Number of Units in Package 3	1200
Package 3 Height	75.000 cm
Package 3 Width	80.000 cm
Package 3 Length	60.000 cm
Package 3 Weight	130.632 kg

Offer Sustainability

REACH Regulation	 REACH Declaration
EU RoHS Directive	Pro-active compliance (Product out of EU RoHS legal scope)  EU RoHS Declaration
Mercury free	Yes
RoHS exemption information	 Yes
California proposition 65	WARNING: This product can expose you to chemicals including: Diisononyl phthalate (DINP), which is known to the State of California to cause cancer, and Di-isodecyl phthalate (DIDP), which is known to the State of California to cause birth defects or other reproductive harm. For more information go to www.P65Warnings.ca.gov

Contractual warranty

Warranty	18 months
----------	-----------

Dimensions

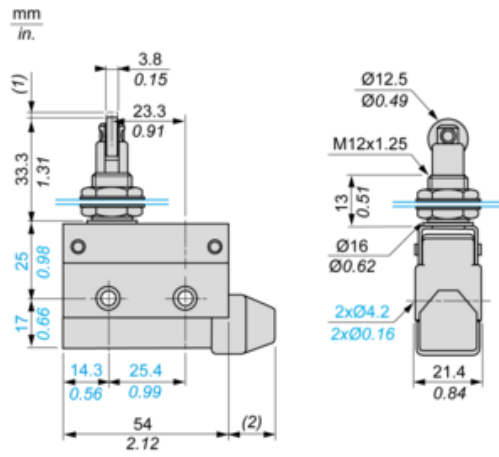

(1) : 2 mm max / 0.07 in. max

(2) : 16.5 mm max / 0.64 in. max

Connection and Schema

Wiring Diagram

Single pole 1C/O



Technical Description

Type of Operator and Functional Diagram, Travel Distance

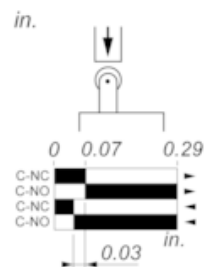
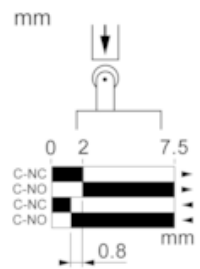

- (1)
 - (2)
 - ▶ (3)
 - ◀ (4)
- (1) : Contact closed
(2) : Contact open
(3) : Tripping
(4) : Resetting

Mounting and Fixing

Recommended

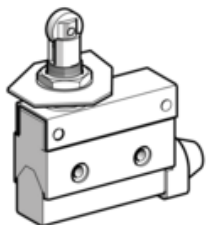

To be Avoided

