



Main

Range of product	Telemecanique Limit switches XC Standard
Series name	Standard format
Product or component type	Limit switch
Device short name	XCKJ
Sensor design	Form D conforming to CENELEC EN 50041
Body type	Fixed
Head type	Rotary head
Material	Metal
Body material	Zamak
Head material	Zamak
Fixing mode	By the body
Movement of operating head	Rotary
Type of operator	Spring return round rod lever thermoplastic round rod 6 mm, L = 200 mm
Type of approach	Lateral approach, 1 or 2 programmable direction
Cable entry	1 entry tapped for M20 x 1.5 cable gland, cable outer diameter: 7...13 mm
Number of poles	2
Contacts type and composition	1 NC + 1 NO
Contact operation	Snap action

Complementary

Switch actuation	By any moving part
Electrical connection	Screw-clamp terminals, clamping capacity: 1 x 0.34...2 x 1.5 mm ²
Contacts insulation form	Zb
Number of steps	1
Positive opening	Without
Minimum torque for tripping	0.25 N.m
Maximum actuation speed	1.5 m/s
[Ie] rated operational current	3 A at 240 V, AC-15, A300 conforming to EN/IEC 60947-5-1 appendix A 0.27 A at 250 V, DC-13, Q300 conforming to EN/IEC 60947-5-1 appendix A
[Ithe] conventional enclosed thermal current	10 A
[Ui] rated insulation voltage	300 V conforming to UL 508 500 V (pollution degree 3) conforming to IEC 60947-1 300 V conforming to CSA C22.2 No 14
Maximum resistance across terminals	25 MOhm conforming to IEC 60255-7 category 3
[Uimp] rated impulse withstand voltage	6 KV conforming to IEC 60664 6 kV conforming to IEC 60947-1
Short-circuit protection	10 A cartridge fuse, type gG
Electrical durability	5000000 Cycles, DC-13, inductive load type, 120 V, 4 W, operating rate <60 cyc/mn, load factor: 0.5 conforming to IEC 60947-5-1 appendix C 5000000 Cycles, DC-13, inductive load type, 24 V, 10 W, operating rate <60 cyc/mn, load factor: 0.5 conforming to IEC 60947-5-1 appendix C 5000000 cycles, DC-13, inductive load type, 48 V, 7 W, operating rate <60 cyc/mn, load factor: 0.5 conforming to IEC 60947-5-1 appendix C
Mechanical durability	30000000 cycles
Width	40 mm

Height	77 mm
Depth	44 mm
Net weight	0.485 kg
Terminals description ISO n°1	(13-14)NO (21-22)NC





Environment

Shock resistance	50 gn for 11 ms conforming to IEC 60068-2-27
Vibration resistance	25 gn (f= 10...500 Hz) conforming to IEC 60068-2-6
IP degree of protection	IP66 conforming to IEC 60529
IK degree of protection	IK07 conforming to EN 50102
Overvoltage category	Class I conforming to IEC 61140 Class I conforming to NF C 20-030
Ambient air temperature for operation	-25...70 °C
Ambient air temperature for storage	-40...70 °C
Protective treatment	TH
Product certifications	CCC CSA UL
Standards	UL 508 IEC 60947-5-1 EN 60947-5-1 CSA C22.2 No 14 IEC 60204-1 CENELEC EN 50041 EN 60204-1

Packing Units

Unit Type of Package 1	PCE
Number of Units in Package 1	1
Package 1 Height	4.2 cm
Package 1 Width	5.7 cm
Package 1 Length	20.7 cm
Package 1 Weight	482.0 g
Unit Type of Package 2	S02
Number of Units in Package 2	14
Package 2 Height	15.0 cm
Package 2 Width	30.0 cm
Package 2 Length	40.0 cm
Package 2 Weight	7.162 kg

Offer Sustainability

Sustainable offer status	Green Premium product
REACH Regulation	 REACH Declaration
EU RoHS Directive	Pro-active compliance (Product out of EU RoHS legal scope)  EU RoHS Declaration
Mercury free	Yes
RoHS exemption information	 Yes
Environmental Disclosure	 Product Environmental Profile
California proposition 65	WARNING: This product can expose you to chemicals including: Diisononyl phthalate (DINP), which is known to the State of California to cause cancer, and Di-isodecyl phthalate (DIDP), which is known to the State of California to cause birth defects or other reproductive harm. For more information go to www.P65Warnings.ca.gov

Contractual warranty

Warranty	18 months
----------	-----------

Dimensions

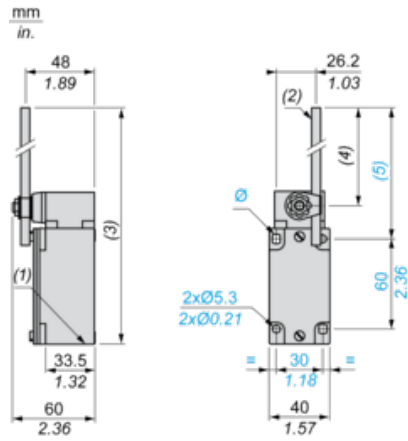

- (1) 1 tapped entry M20 x 1.5
- (2) Ø 6 rod, length 200 mm.
- (3) 282 max.
- (4) 190 max.
- (5) 212 max.
- Ø : 2 elongated holes Ø 5.3 x 7.3.

Mounting with Cable Entry

Position of Cable Gland



- (1) Recommended
- (2) To be avoided

Mounting with Rotary Heads and Levers

Type of Cam



- (1) Recommended
- (2) To be avoided

Setting-up with Lever Head



- (1) 5° steps throughout 360° / Tightening torque (Min : 1) (Max : 1.5)
- (2) 45° steps throughout 360° / Tightening torque (Min : 1) (Max : 1.5)
- (a) Tightening torque (Min : 1) (Max : 1.5)

Setting-up with Head ZCKE05

Direction of Actuation Programming



Wiring Diagram

2-pole NC + NO Snap Action



Characteristics of Actuation

Switch Actuation by Any Moving Part

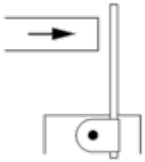

Functionnal Diagram

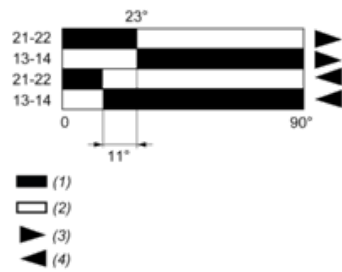

- (1) Closed
- (2) Open
- (3) Tripping
- (4) Resetting