



## Main

Range of product	OsiSense ATEX D
Series name	Special format
Product or component type	Limit switch
Product specific application	For conveyor belt shift monitoring
Device short name	XCR
Body type	Fixed
Head type	Rotary head
Material	Metal
Fixing mode	By the body
Movement of operating head	Rotary
Type of operator	Spring return roller zinc plated steel with lever
Switch actuation	By conveyor belt
Type of approach	Lateral approach, 2 directions
Electrical connection	Screw-clamp terminals, clamping capacity: 1 x 0.5...2 x 2.5 mm <sup>2</sup>
Cable entry number	1 tapped entry for Pg 13.5 cable gland (included) 9...12 mm
Number of poles	2
Contacts type and composition	2 x 1 C/O
Contacts insulation form	Za
Contact operation	Snap action
Number of steps	2
Contact block per direction [control circuit]	1 per direction
Positive opening	With
Minimum torque for tripping	1 N.m
Maximum actuation speed	1.5 m/s
IP degree of protection	IP65 conforming to IEC 60529

## Complementary

Body material	Zinc alloy
Minimum actuation speed	0.01 m/min
Tripping angle	10 ° for fault signalling 18 ° for stopping of the conveyor belt
Maximum displacement angle	-90 ° 90 °
Contact code designation	A300, AC-15 (U <sub>e</sub> = 240 V), I <sub>e</sub> = 3 A conforming to EN 60947-5-1 A300, AC-15 (U <sub>e</sub> = 240 V), I <sub>e</sub> = 3 A conforming to IEC 60947-5-1 appendix A Q300, DC-13 (U <sub>e</sub> = 250 V), I <sub>e</sub> = 0.27 A conforming to EN 60947-5-1 Q300, DC-13 (U <sub>e</sub> = 250 V), I <sub>e</sub> = 0.27 A conforming to IEC 60947-5-1 appendix A
[Ui] rated insulation voltage	300 V conforming to UL 508 500 V conforming to NF C 20-040 group C 500 V (pollution degree 3) conforming to IEC 60947-1 500 V (pollution degree 3) conforming to VDE 0110
Maximum resistance across terminals	25 MOhm conforming to IEC 60255-7 category 3 25 MOhm conforming to NF C 93-050 method A

[Uimp] rated impulse withstand voltage	6 KV conforming to IEC 60664 6 kV conforming to IEC 60947-1
Short-circuit protection	10 A cartridge fuse, type gG
Electrical durability	5000000 Cycles, DC-13, inductive load type, 120 V, 4 W, operating rate <3600 cyc/mn, load factor: 0.5, DC conforming to IEC 60947-5-1 appendix C 5000000 Cycles, DC-13, inductive load type, 24 V, 10 W, operating rate <3600 cyc/mn, load factor: 0.5, DC conforming to IEC 60947-5-1 appendix C 5000000 cycles, DC-13, inductive load type, 48 V, 7 W, operating rate <3600 cyc/mn, load factor: 0.5, DC conforming to IEC 60947-5-1 appendix C
Mechanical durability	300000 cycles
Marking	II2 D-Ex tb IIIC T85°C Db IP66/67
Width	85 mm
Height	95 mm
Depth	75 mm



## Environment

Shock resistance	30 gn for 18 ms conforming to IEC 60068-2-27
Vibration resistance	9 gn (f= 10...500 Hz) conforming to IEC 60068-2-6
Electrical shock protection class	Class I conforming to IEC 60536 Class I conforming to NF C 20-030
Ambient air temperature for operation	-20...60 °C
Protective treatment	TC
Dust zone	Zone 21 - 22
Product certifications	INERIS 04ATEX0014X IEC-Ex INE 16.0048X
Standards	EN/IEC 60079-31 EN/IEC 60079-0
Directives	2014/34/EU - ATEX directive

## Packing Units

Unit Type of Package 1	PCE
Number of Units in Package 1	1
Package 1 Height	10.000 cm
Package 1 Width	9.300 cm
Package 1 Length	23.500 cm
Package 1 Weight	1.295 kg
Unit Type of Package 2	S03
Number of Units in Package 2	8
Package 2 Height	30.000 cm
Package 2 Width	30.000 cm
Package 2 Length	40.000 cm
Package 2 Weight	10.860 kg
Unit Type of Package 3	P06
Number of Units in Package 3	64
Package 3 Height	75.000 cm
Package 3 Width	60.000 cm
Package 3 Length	80.000 cm
Package 3 Weight	95.380 kg

## Offer Sustainability

Sustainable offer status	Green Premium product
REACH Regulation	 <a href="#">REACH Declaration</a>
EU RoHS Directive	Pro-active compliance (Product out of EU RoHS legal scope)  <a href="#">EU RoHS Declaration</a>
Mercury free	Yes
RoHS exemption information	 <a href="#">Yes</a>

---

Environmental Disclosure	<a href="#">Product Environmental Profile</a>
California proposition 65	WARNING: This product can expose you to chemicals including: Diisononyl phthalate (DINP), which is known to the State of California to cause cancer, and Di-isodecyl phthalate (DIDP), which is known to the State of California to cause birth defects or other reproductive harm. For more information go to <a href="http://www.P65Warnings.ca.gov">www.P65Warnings.ca.gov</a>

---

### Contractual warranty

---

Warranty	18 months
----------	-----------

---

## Dimensions

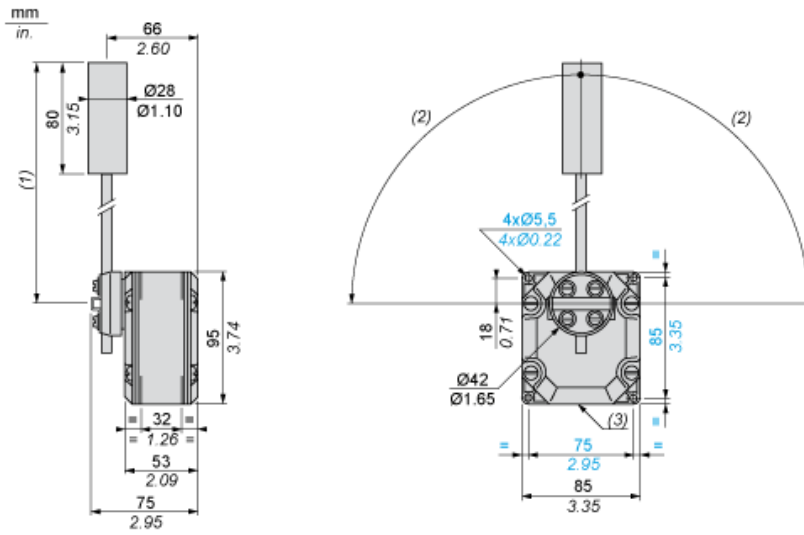

- (1) 200 mm max. 104 mm min.  
(2) 90° max.  
(3) 1 tapped entry for Pg 13.5 cable gland

## Wiring Diagram

### 2 Single-pole CO Snap Action

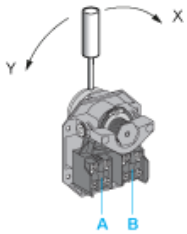

- (A) 1<sup>st</sup> contact
- (B) 2<sup>nd</sup> contact

### 2 Single-pole CO Snap Action

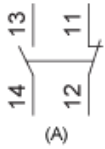

(A)

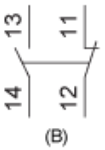

(B)

- (A) 1<sup>st</sup> contact
- (B) 2<sup>nd</sup> contact

Functionnal Diagram

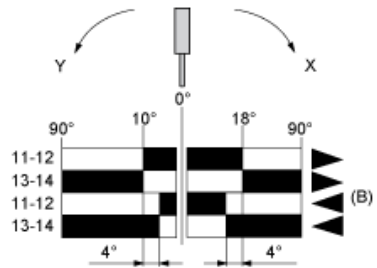
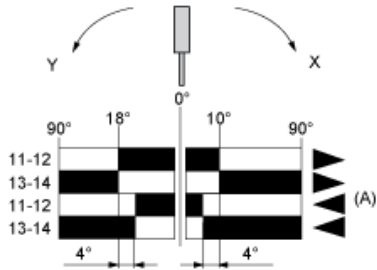

- (1)
- (2)
- ▶ (3)
- ◀ (4)

- (A) 1st contact
- (B) 2nd contact
- (1) Closed
- (2) Open
- (3) Tripping
- (4) Resetting